

DIGIT CUBE

#BUILDING_INSTRUCTION

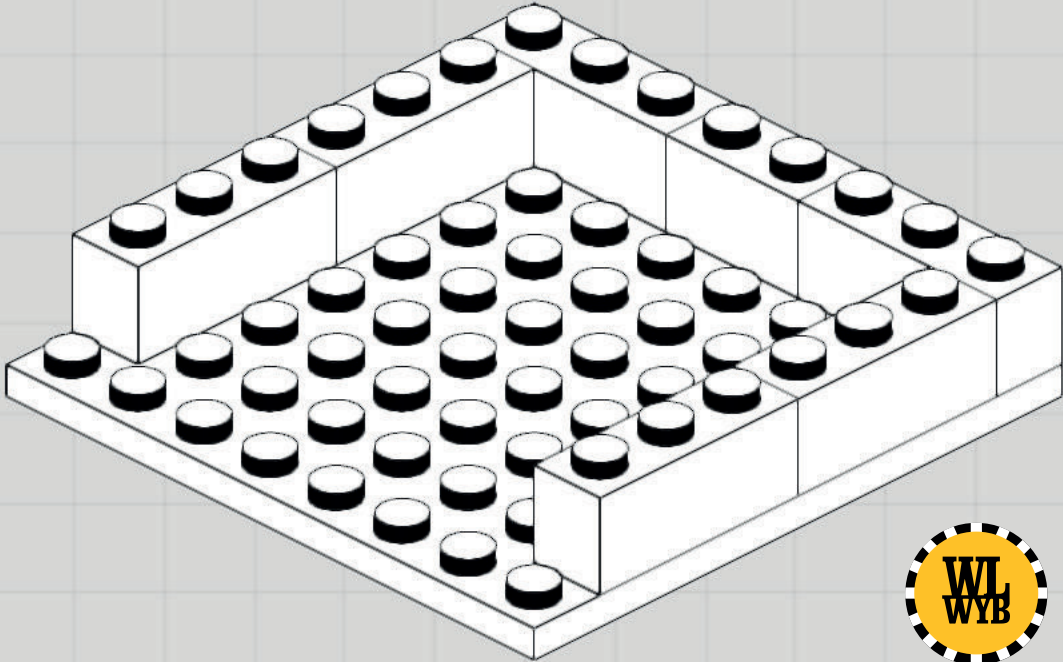

1

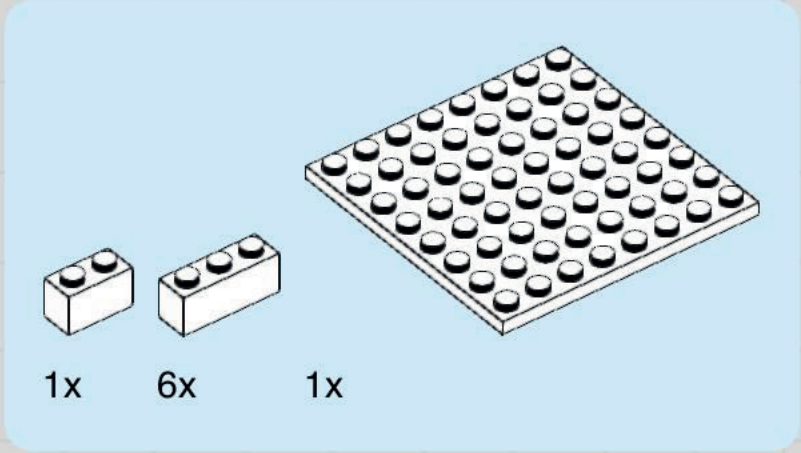

2

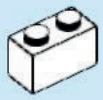

1x

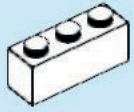

2x

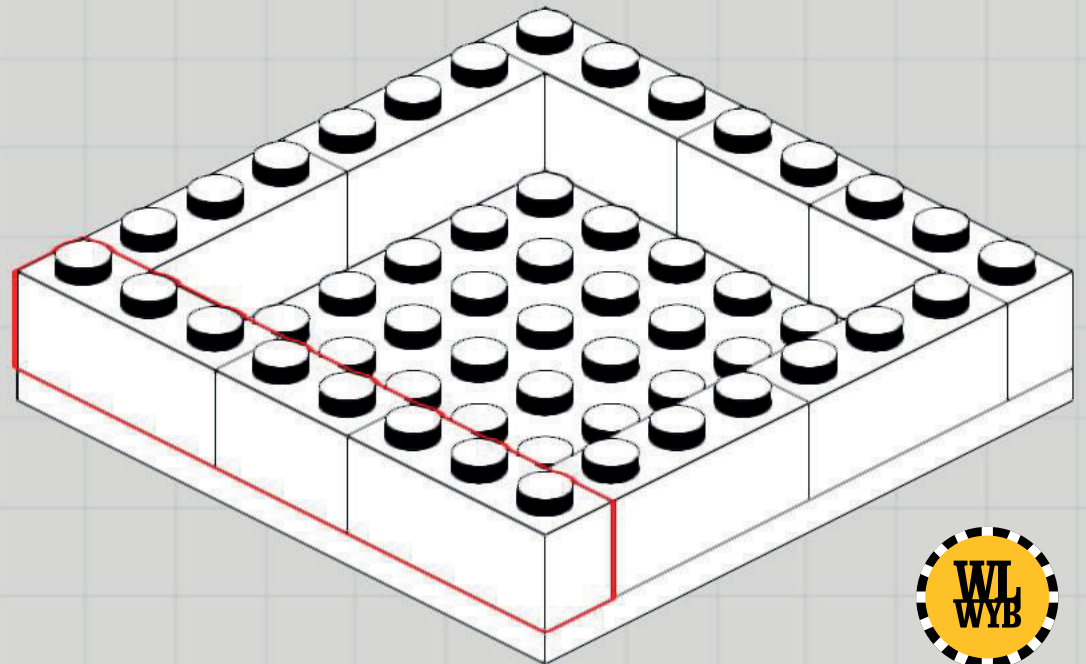

3

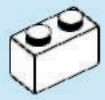

2x

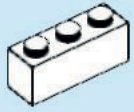

6x

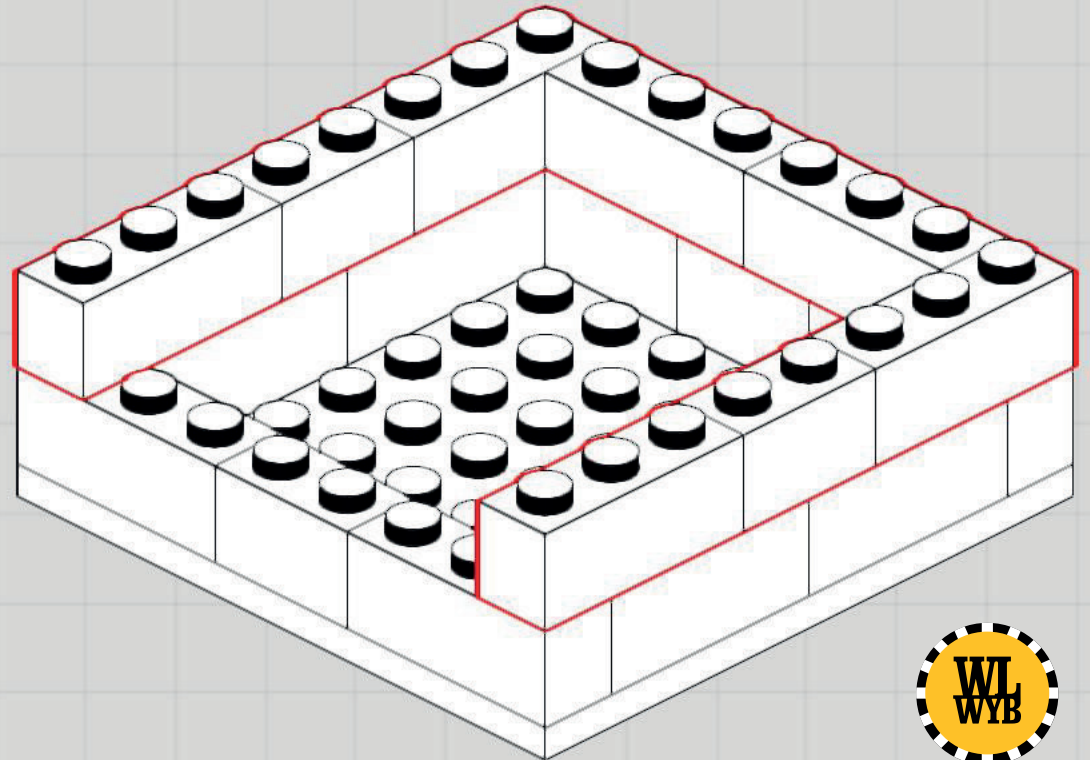

4

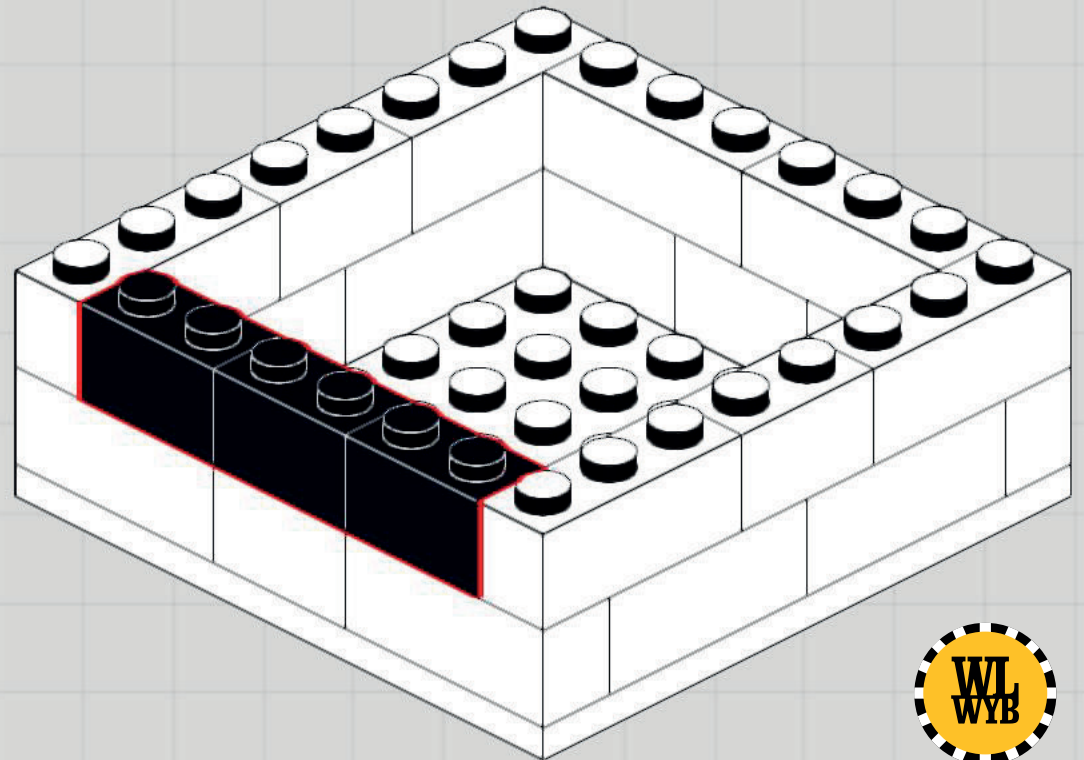

5

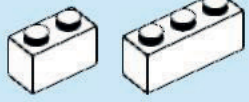

1x

6x



Side Step: Croon
'Eye Of The Tiger' to get
into an epic mood. (Optional,
but recommended.)

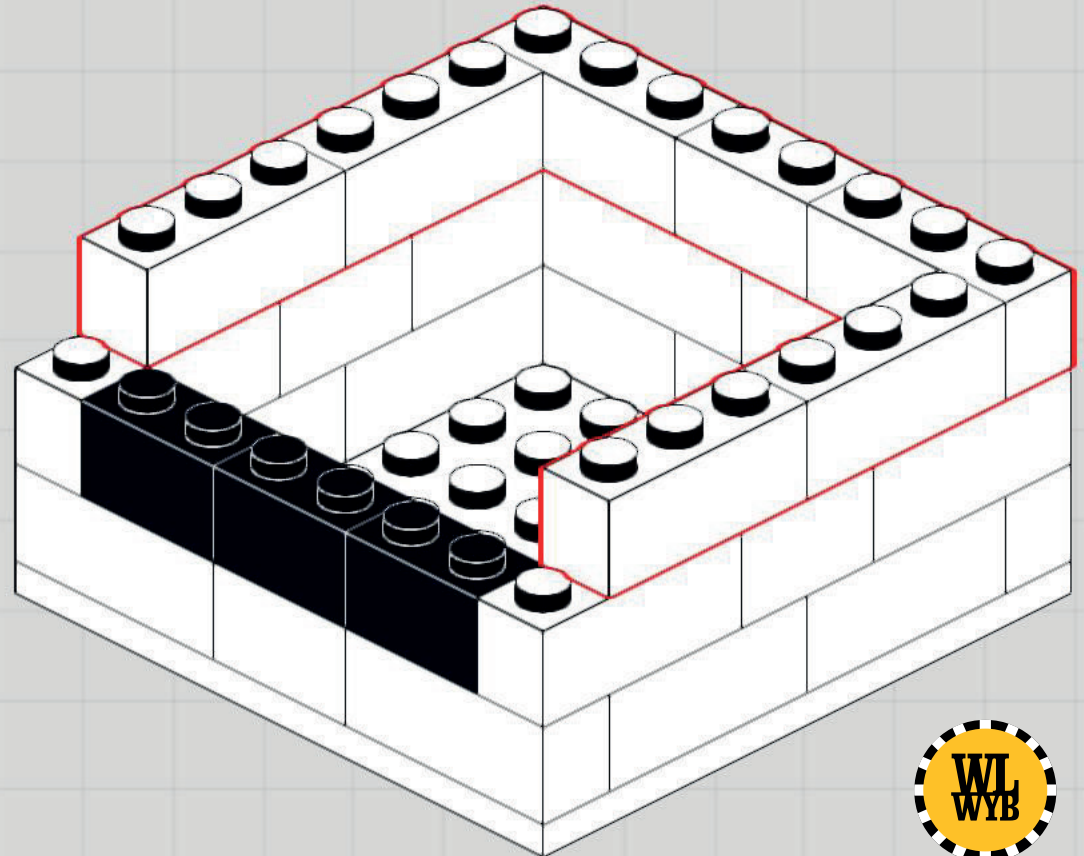

6

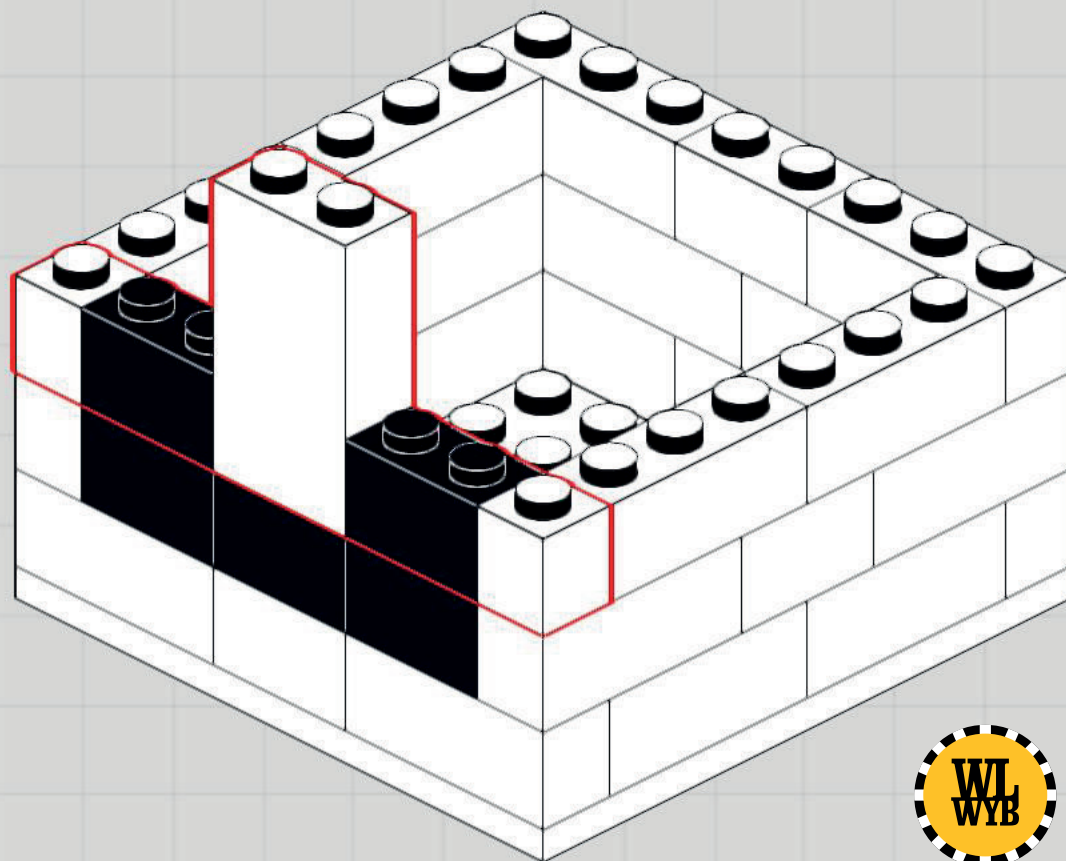
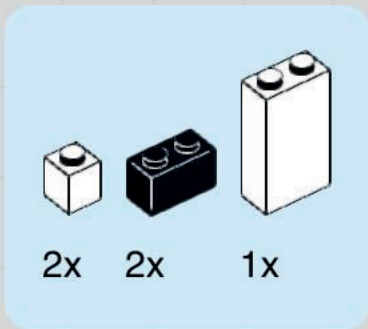

7

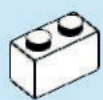

2x

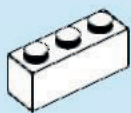

6x

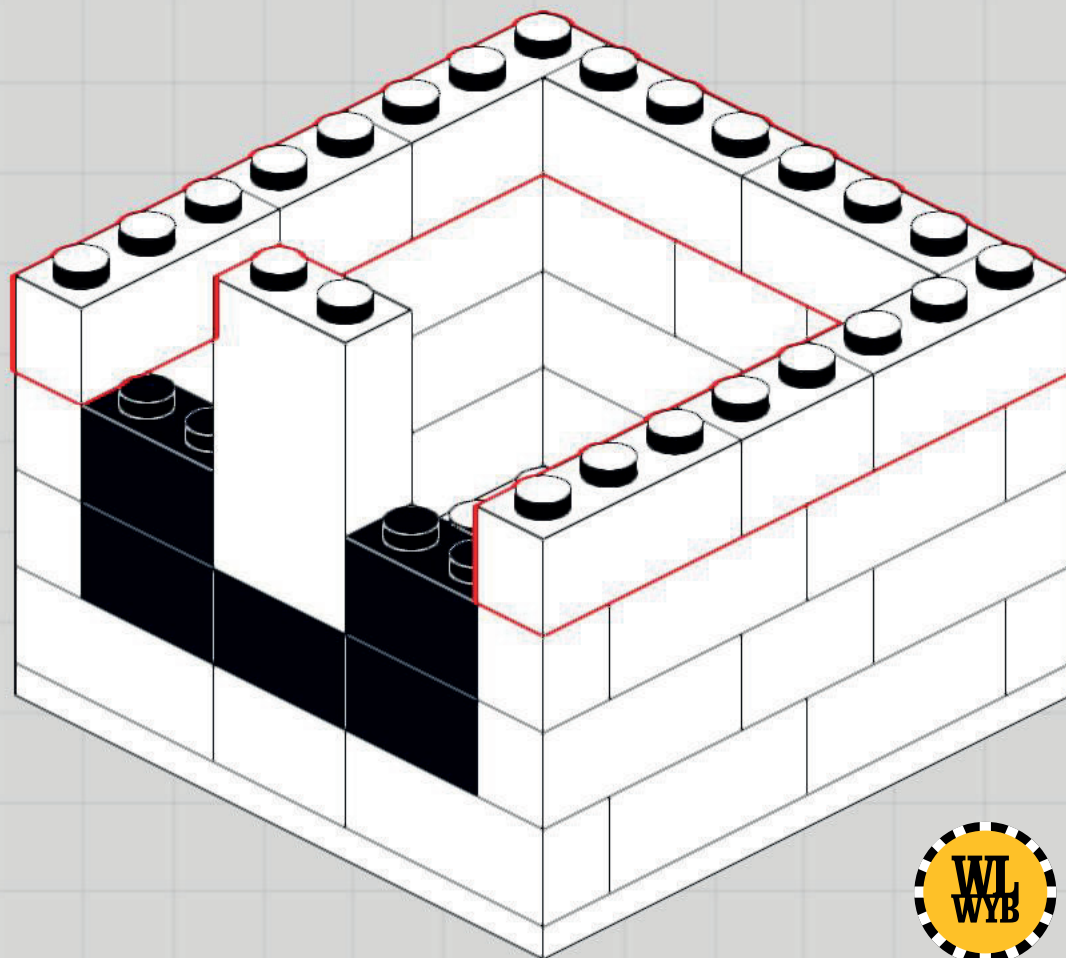

8

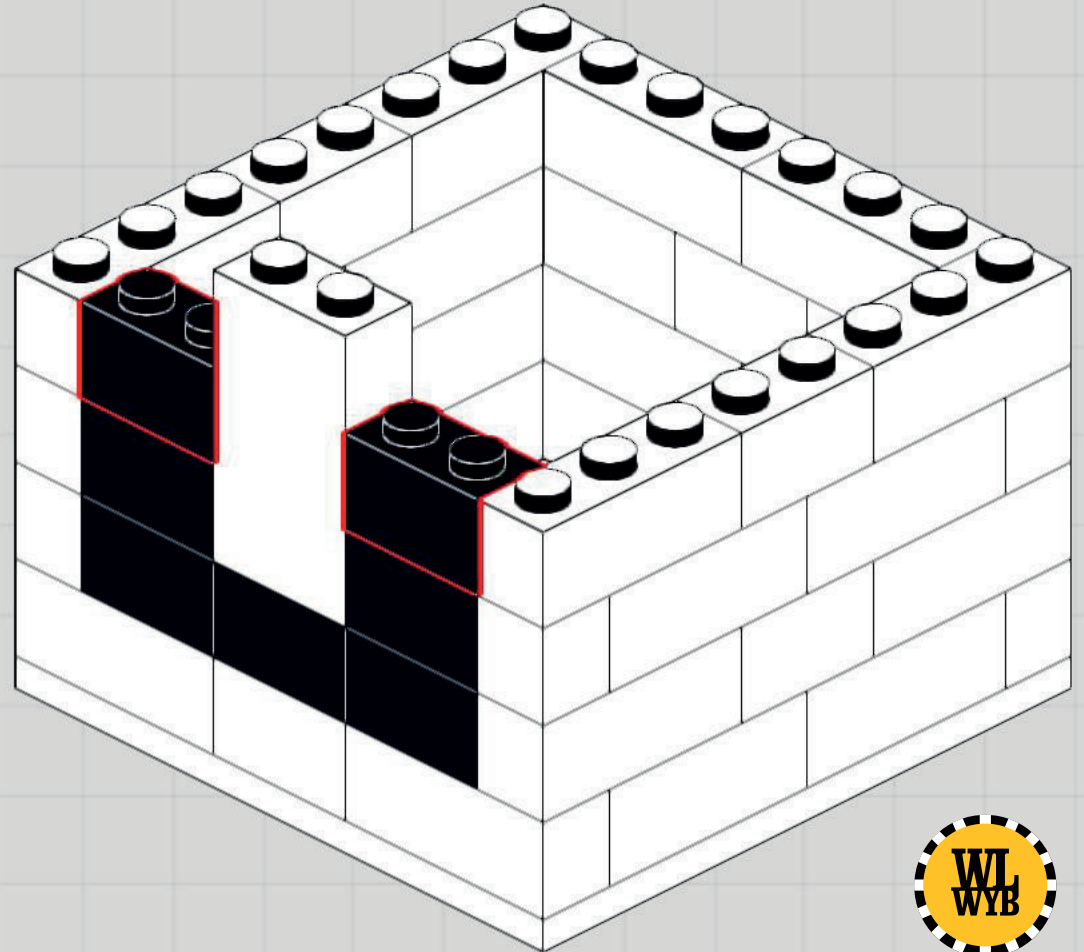

9



1x

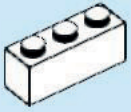

6x

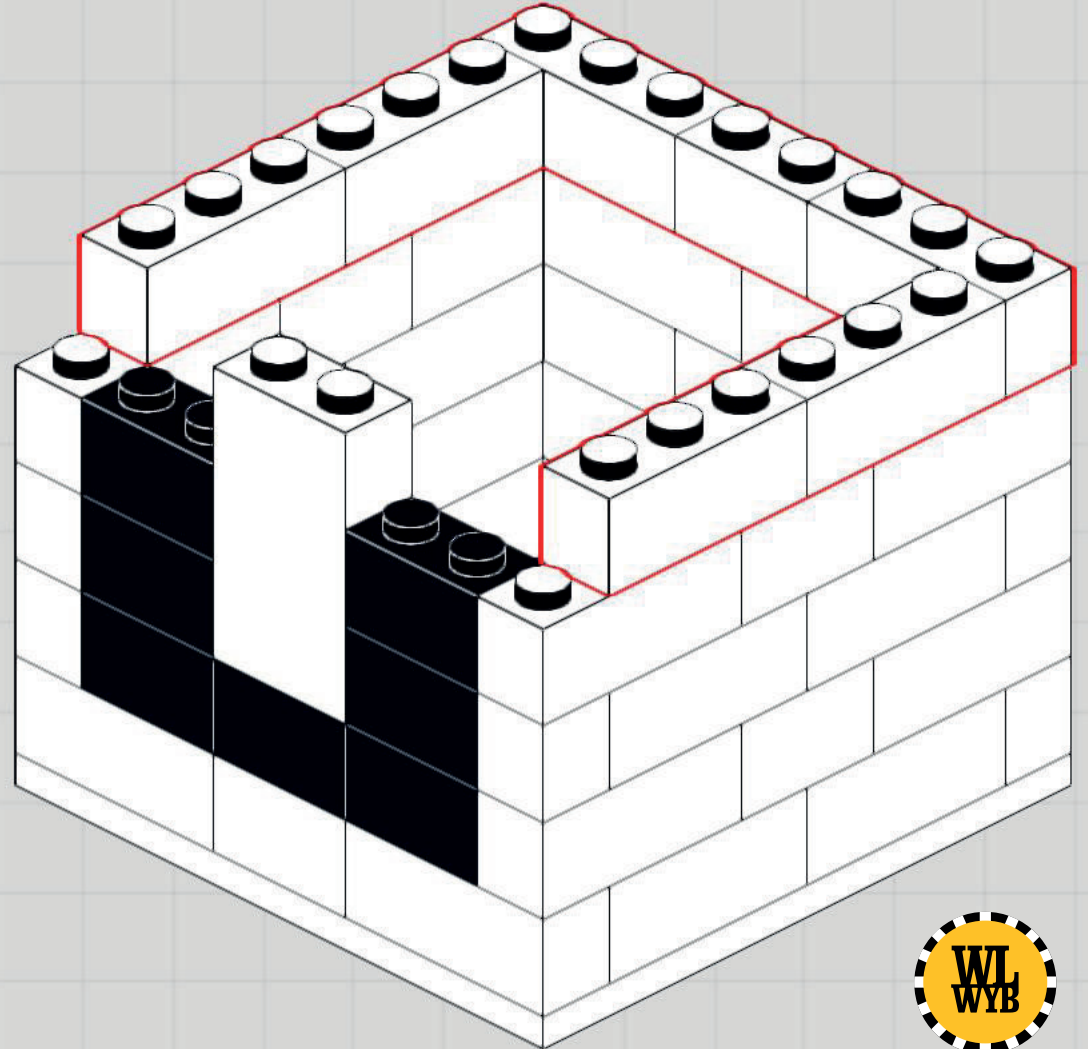

10

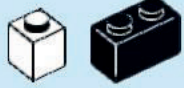

2x

2x



Pro Tip: Build with your legs with eyes wide open.

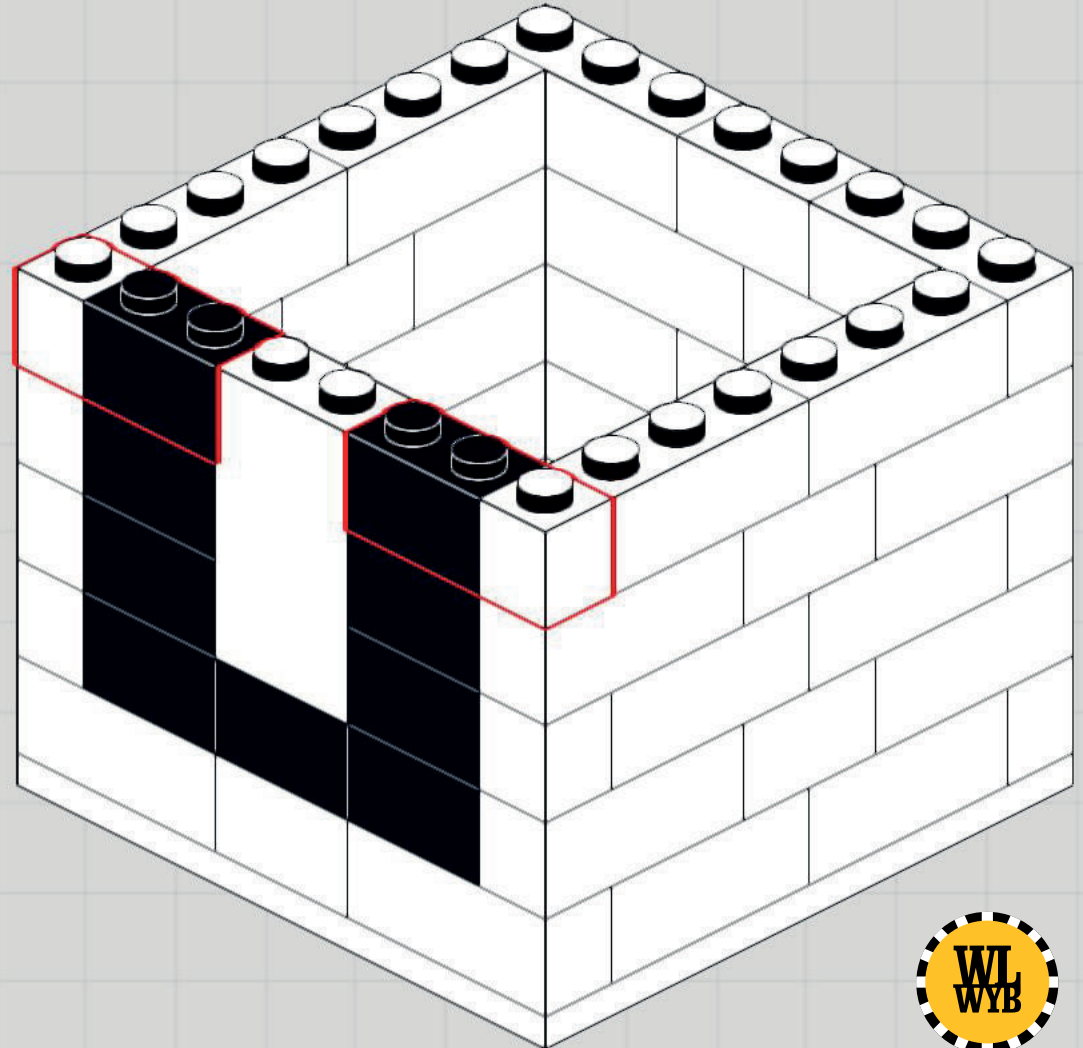

11

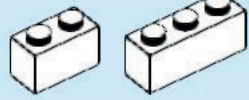

2x

6x

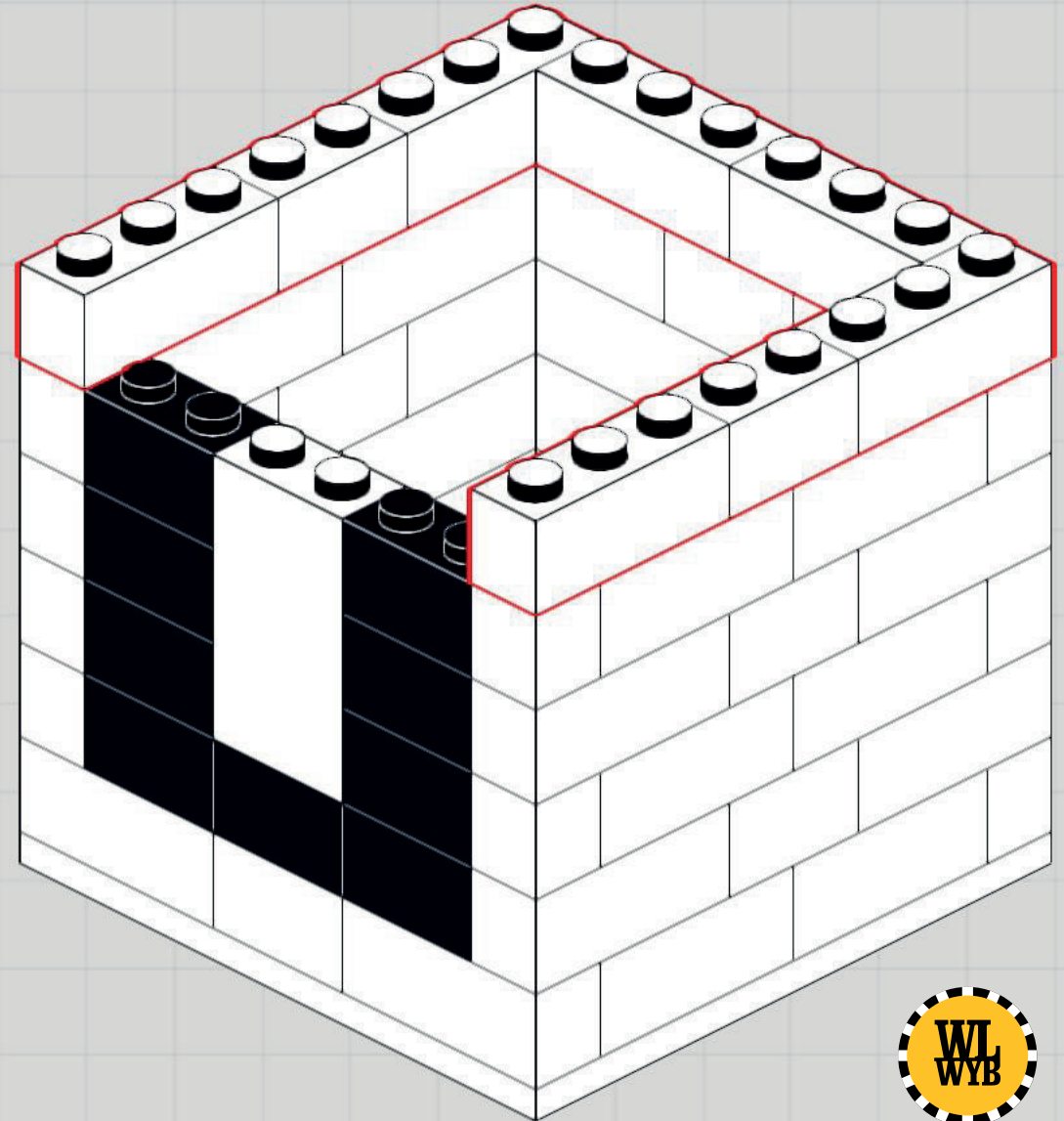

12



3x

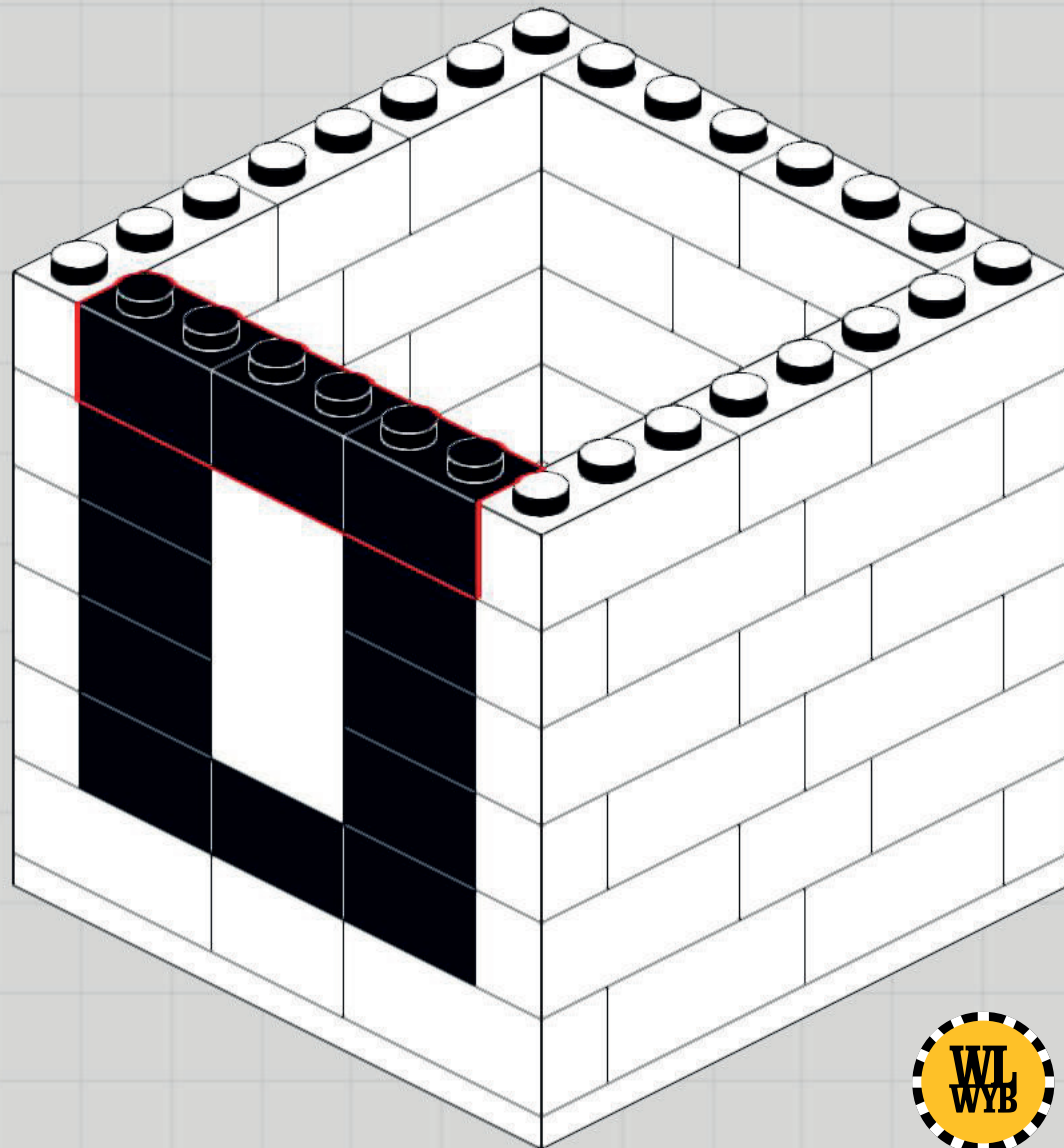

13

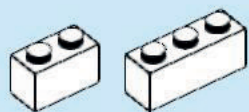

1x

6x

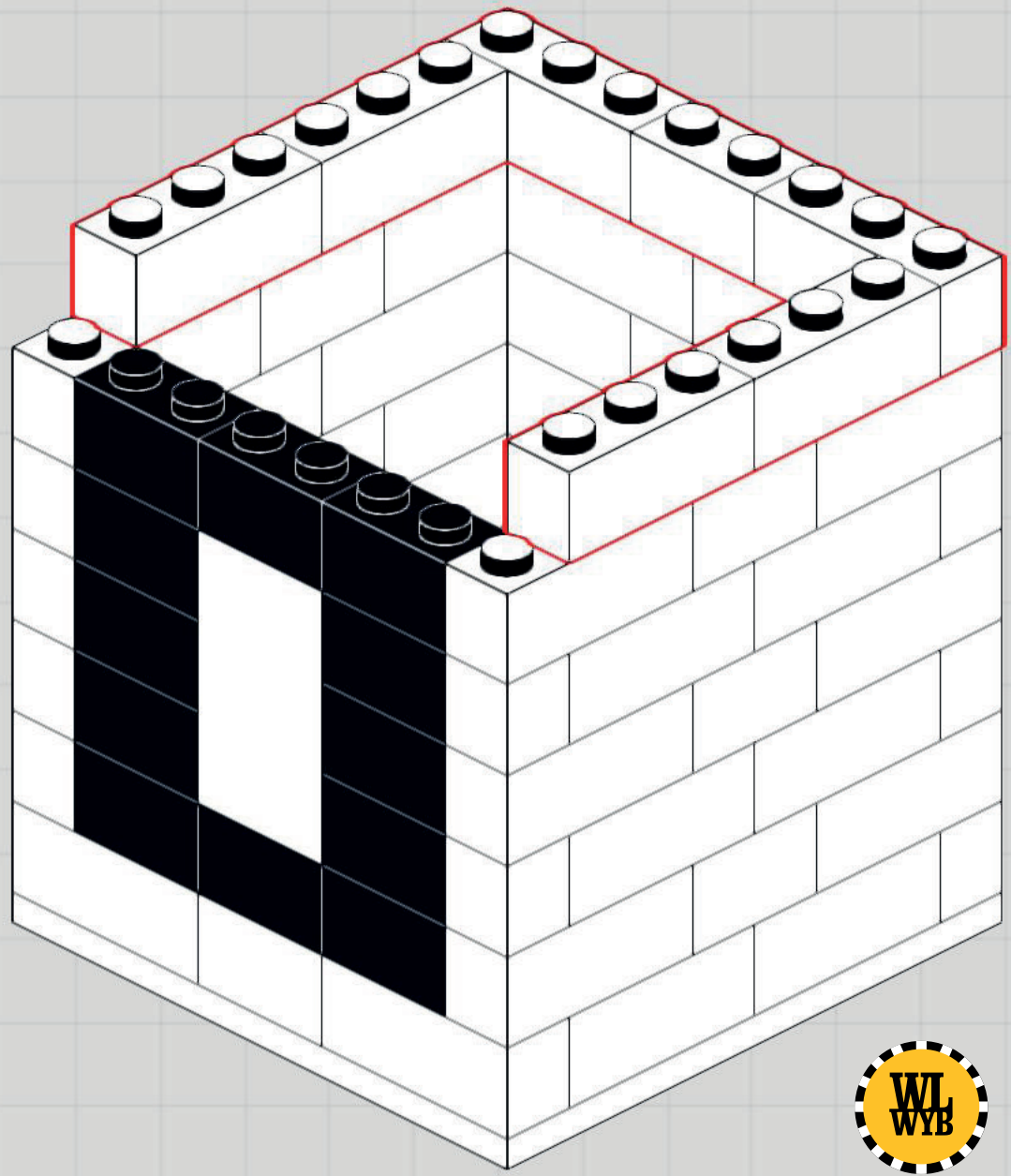

14

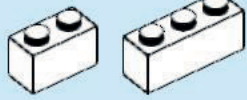

1x

2x

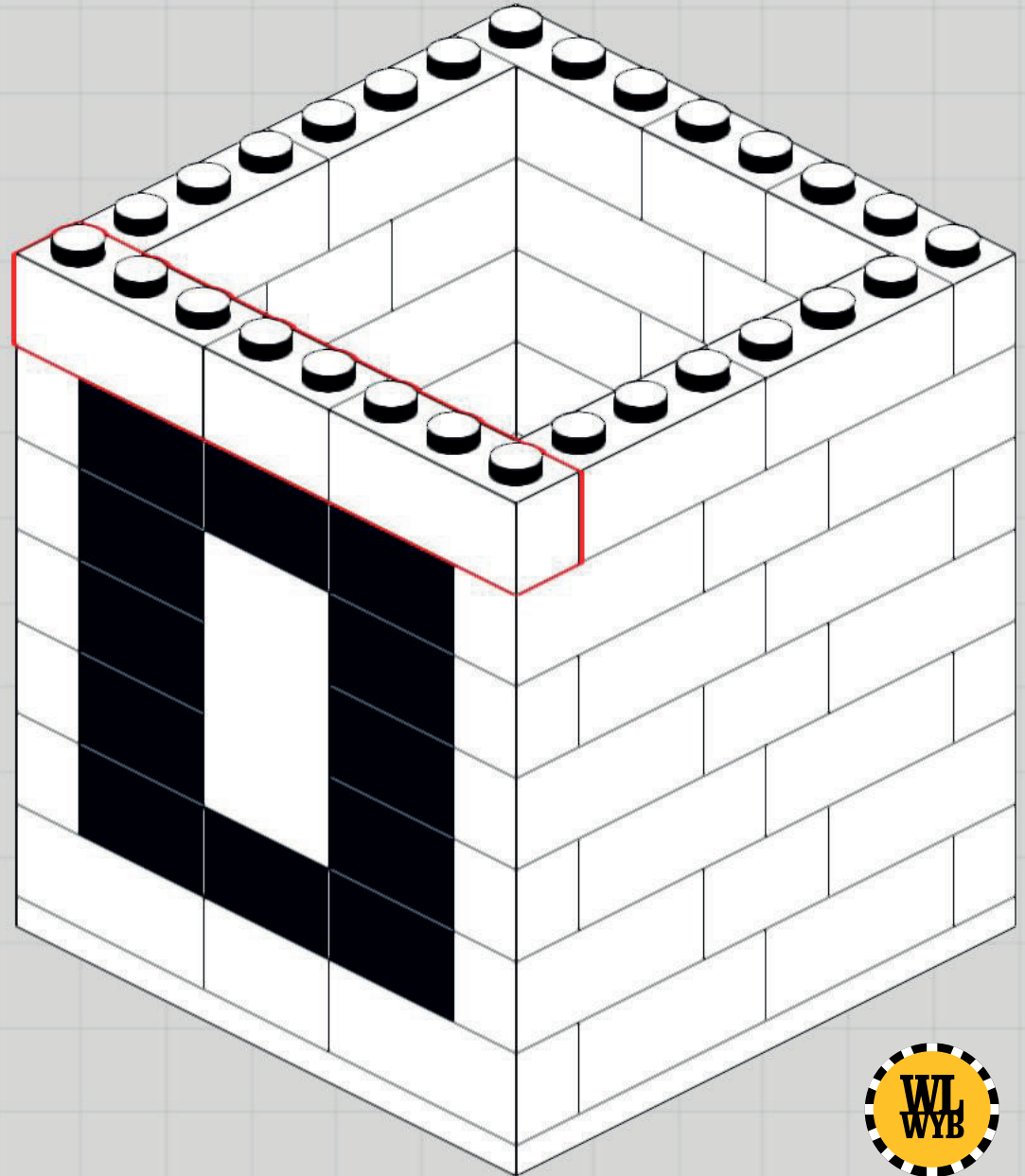

15

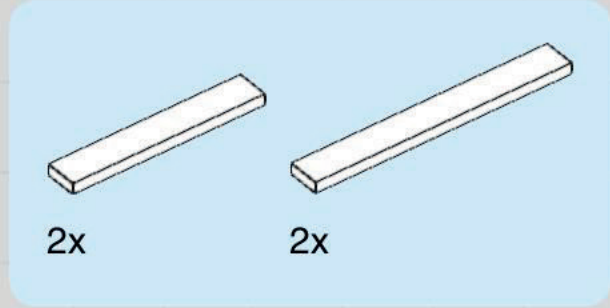

Now might be a good time to refresh your drink.

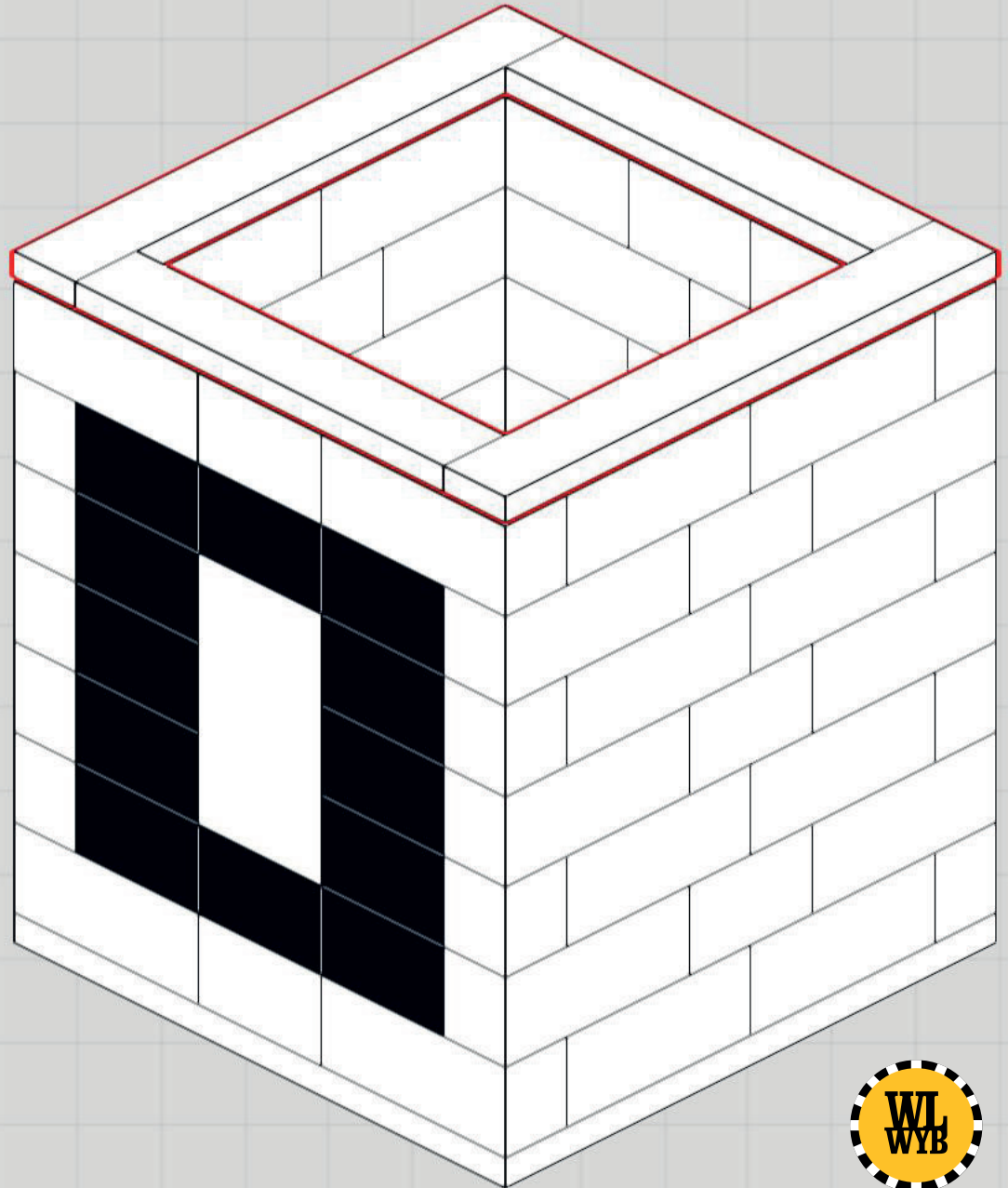

IMPORTANT:

Do not bleach or iron.

Do not bend, fold, spindle or mutilate.

Do not show your weakness.

Do not lock your keys in the car.

Do not wear white socks with black shoes.

DIGIT CUBE

www.wlwyb.com

