

DIGIT CUBE

#BUILDING_INSTRUCTION

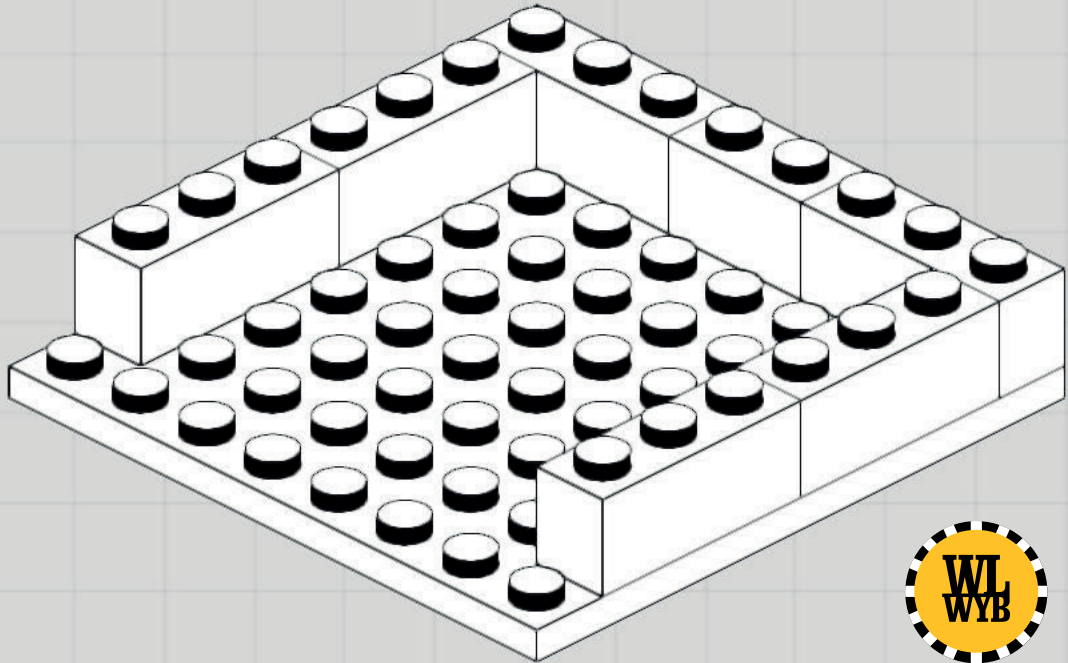

1

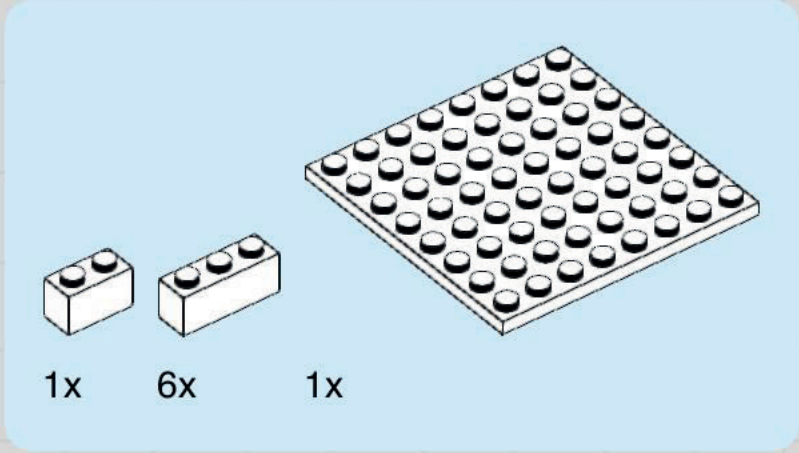

2

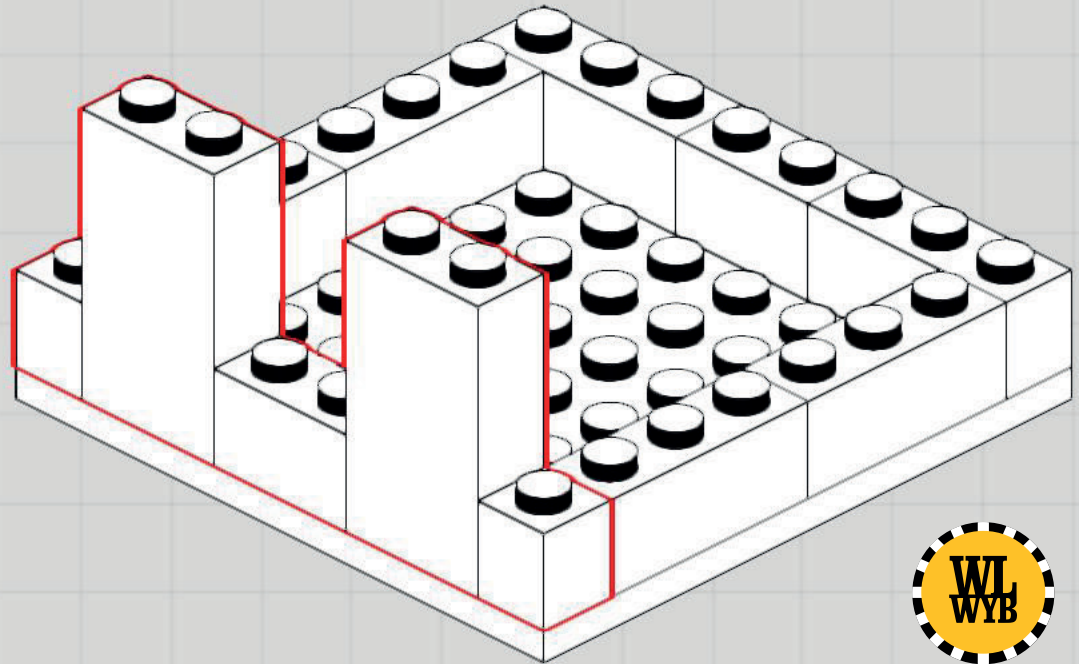
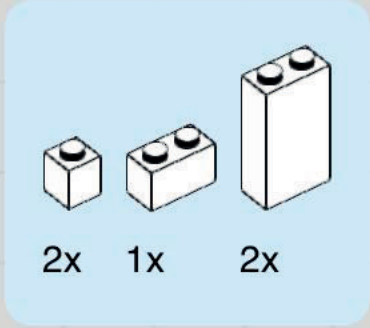

3



2x

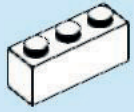

6x

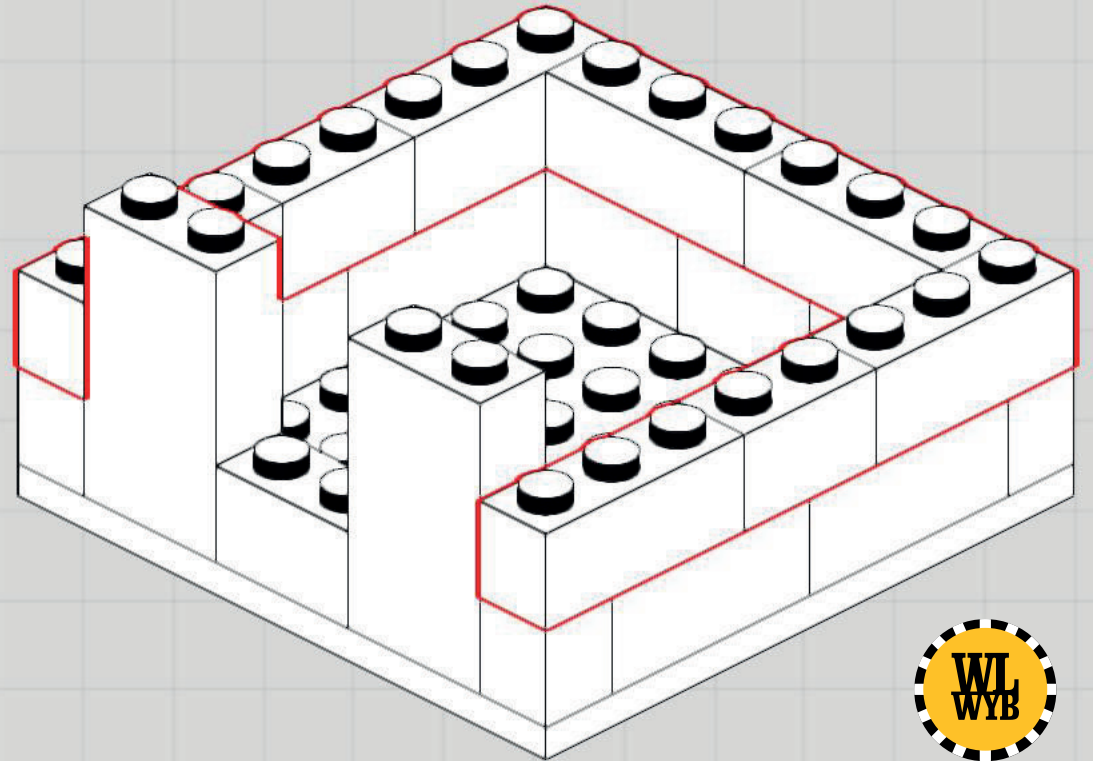

4

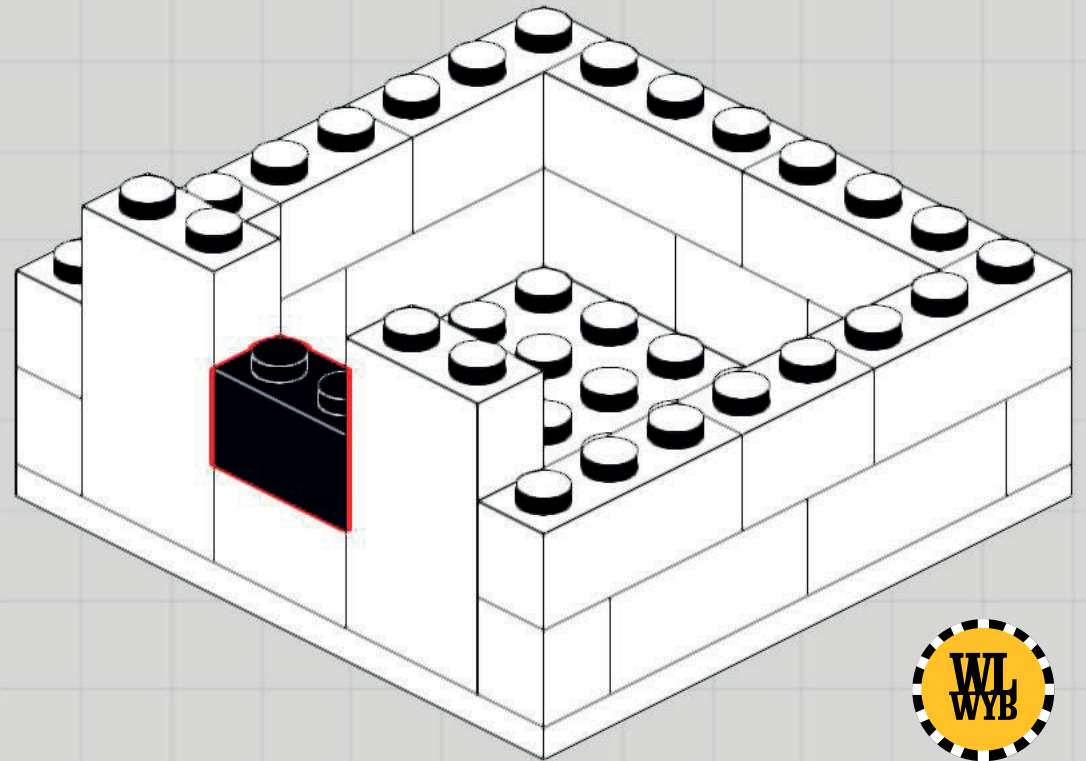

5

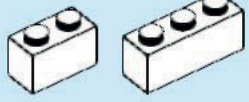

1x

6x



Scream abra cadabra
as loud as you can.
You deserve it.

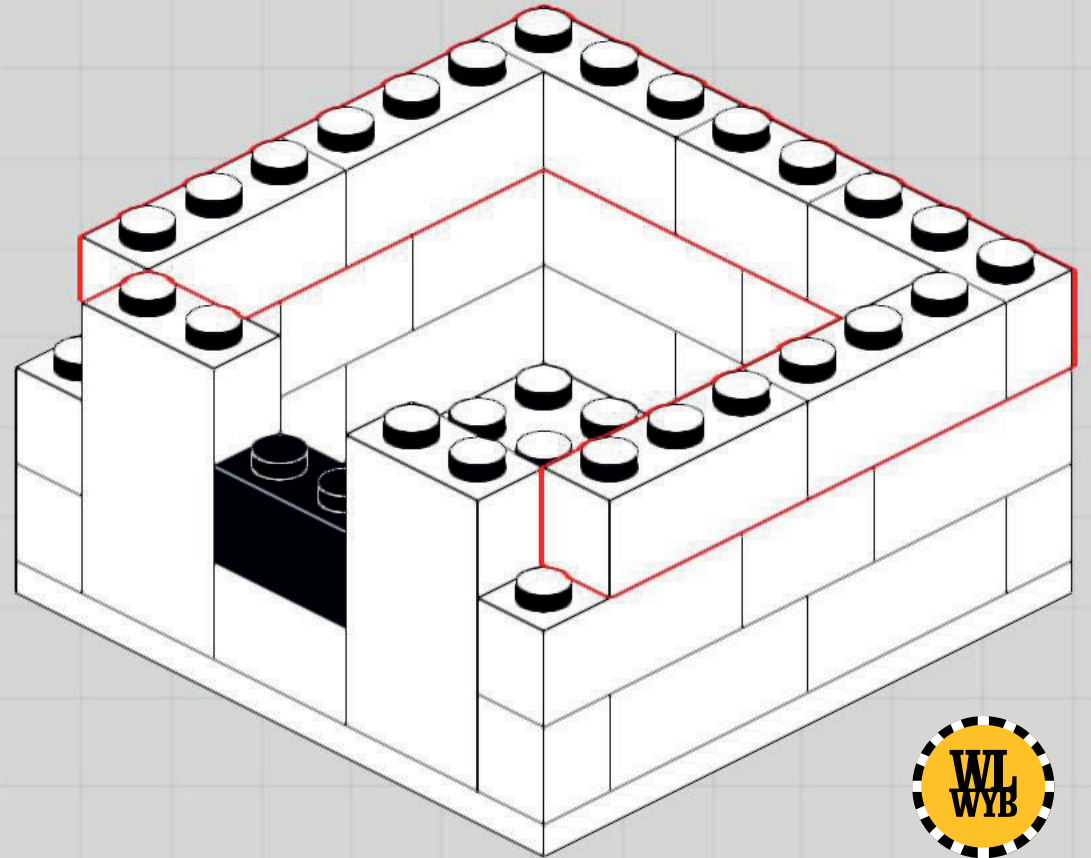

6



2x

1x

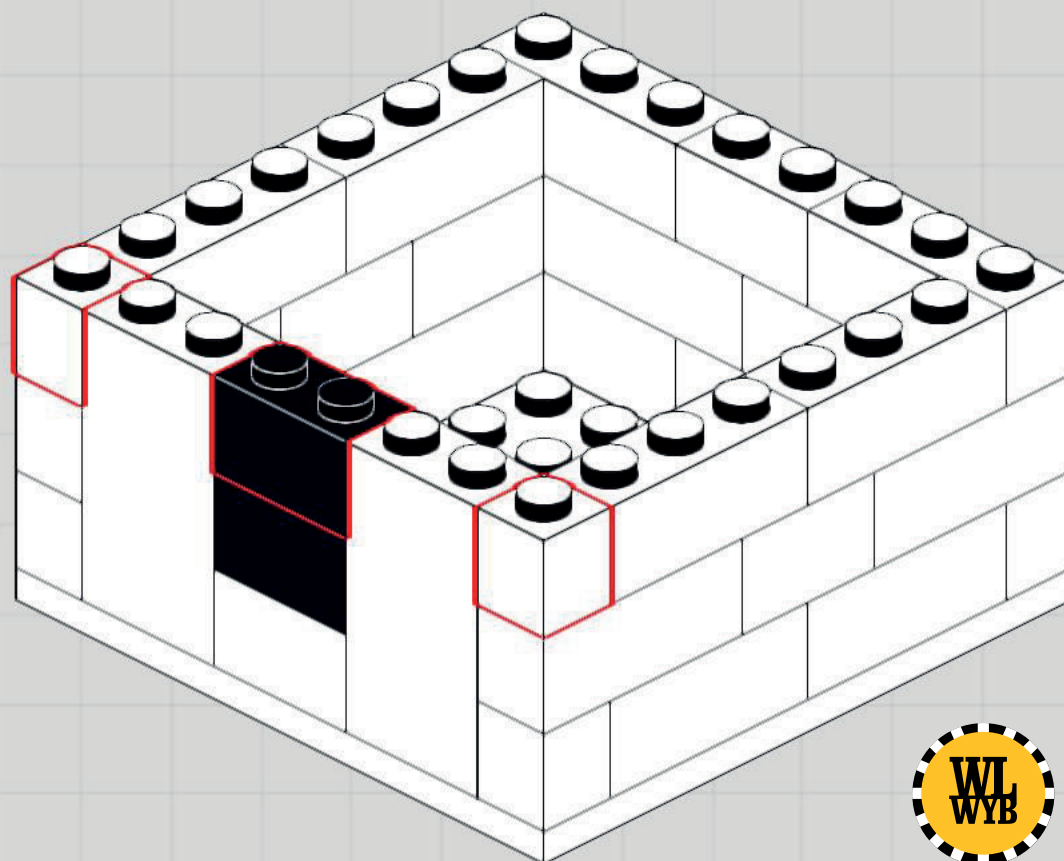

7



2x

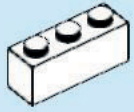

6x

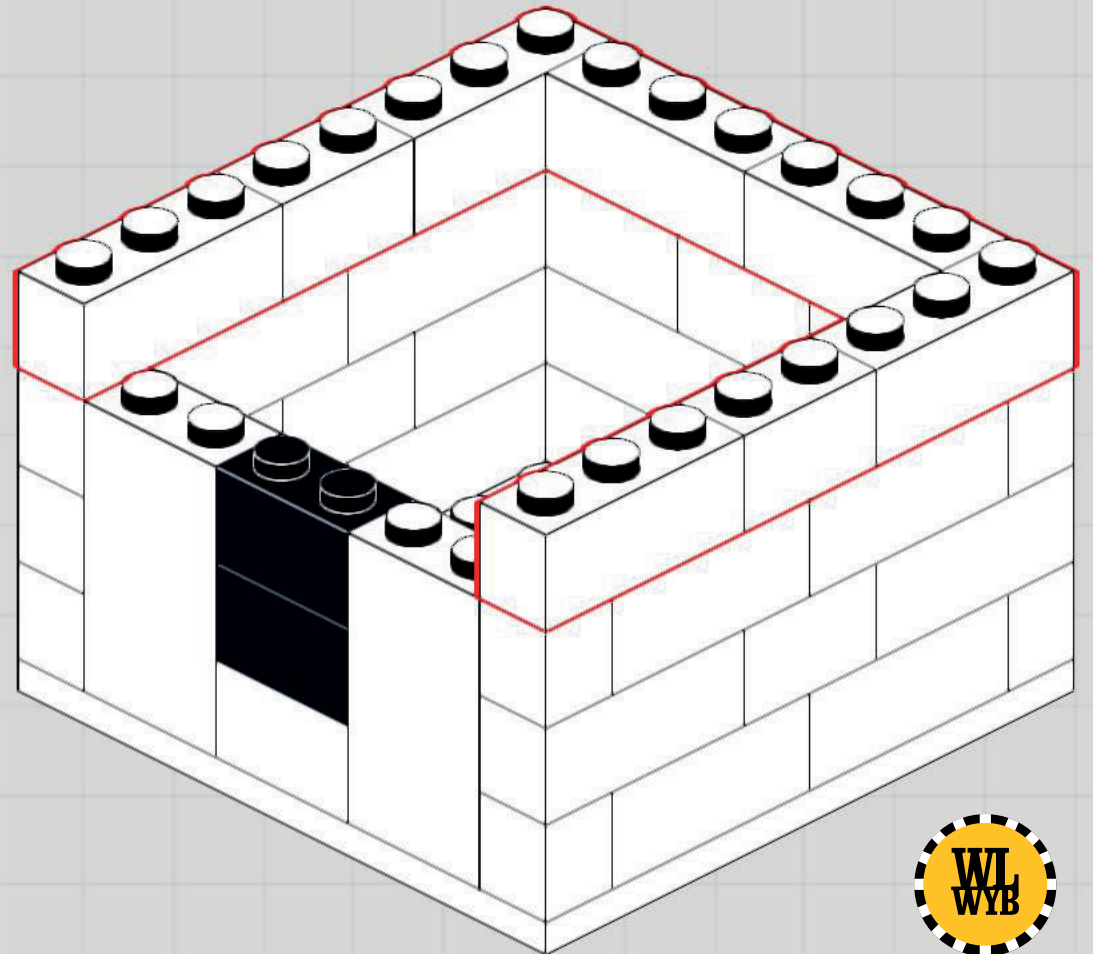

8



2x

2x

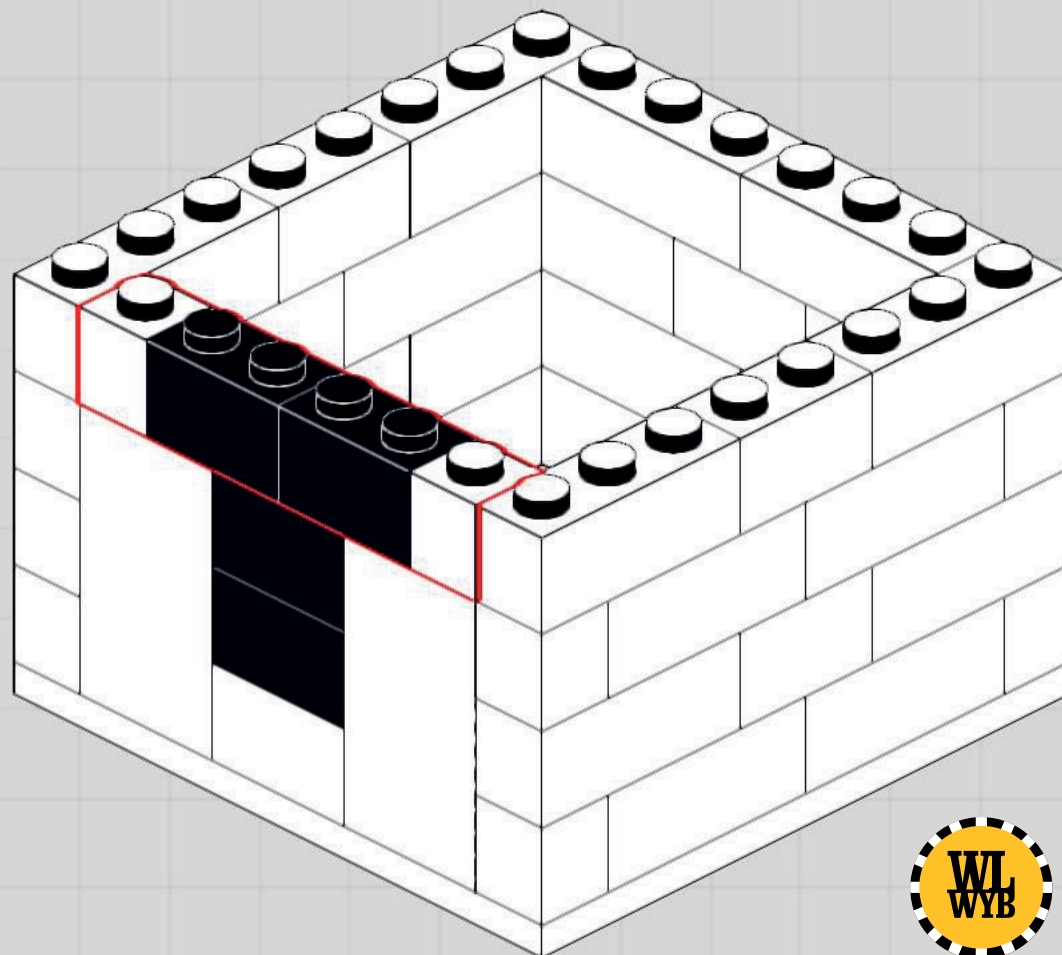

9



1x

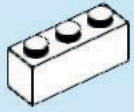

6x

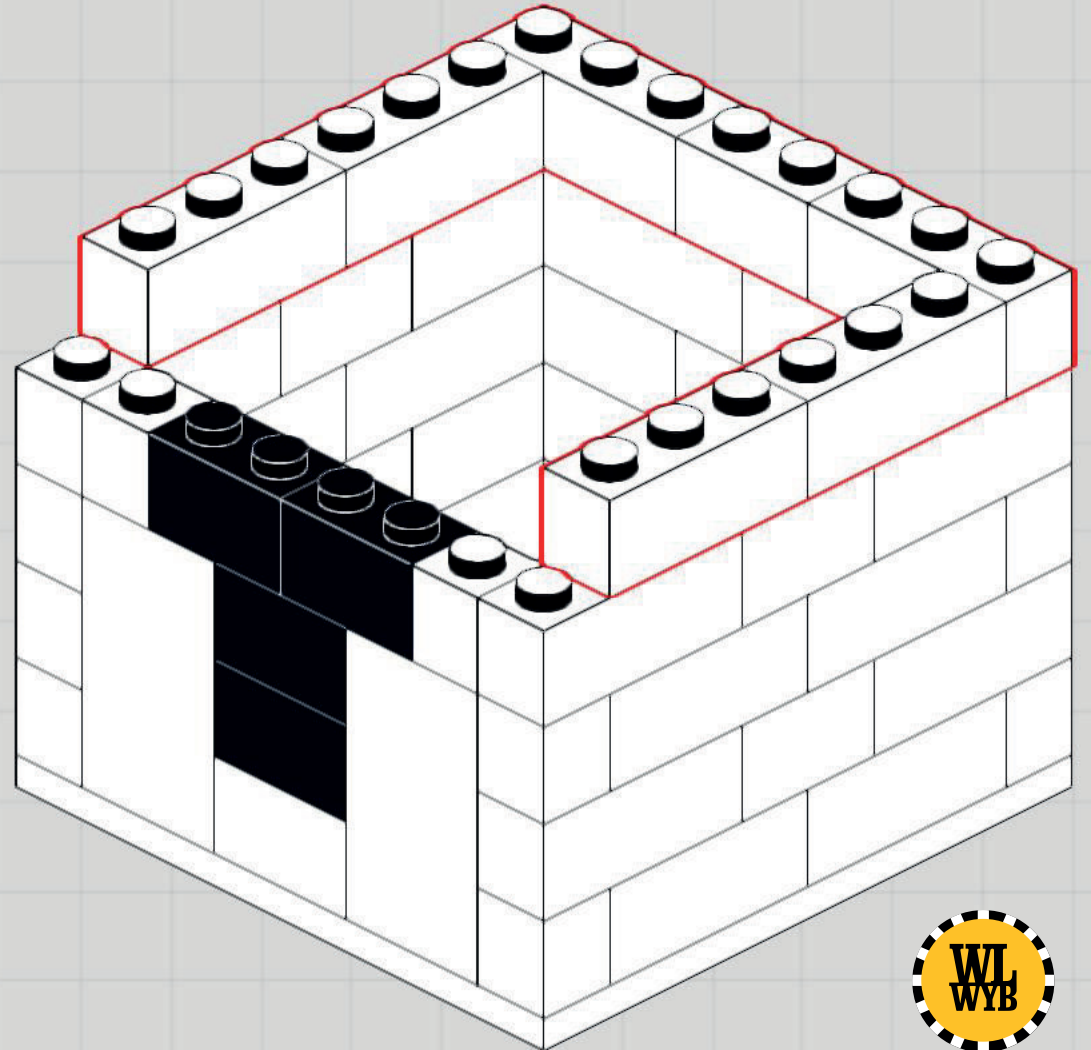

10

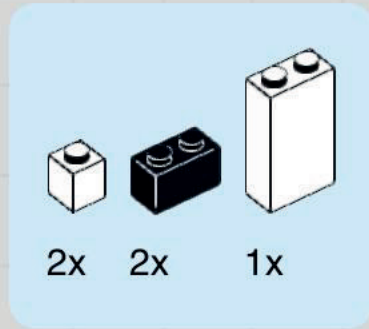

Pro Tip:
Start from the end.
Build it backwards.

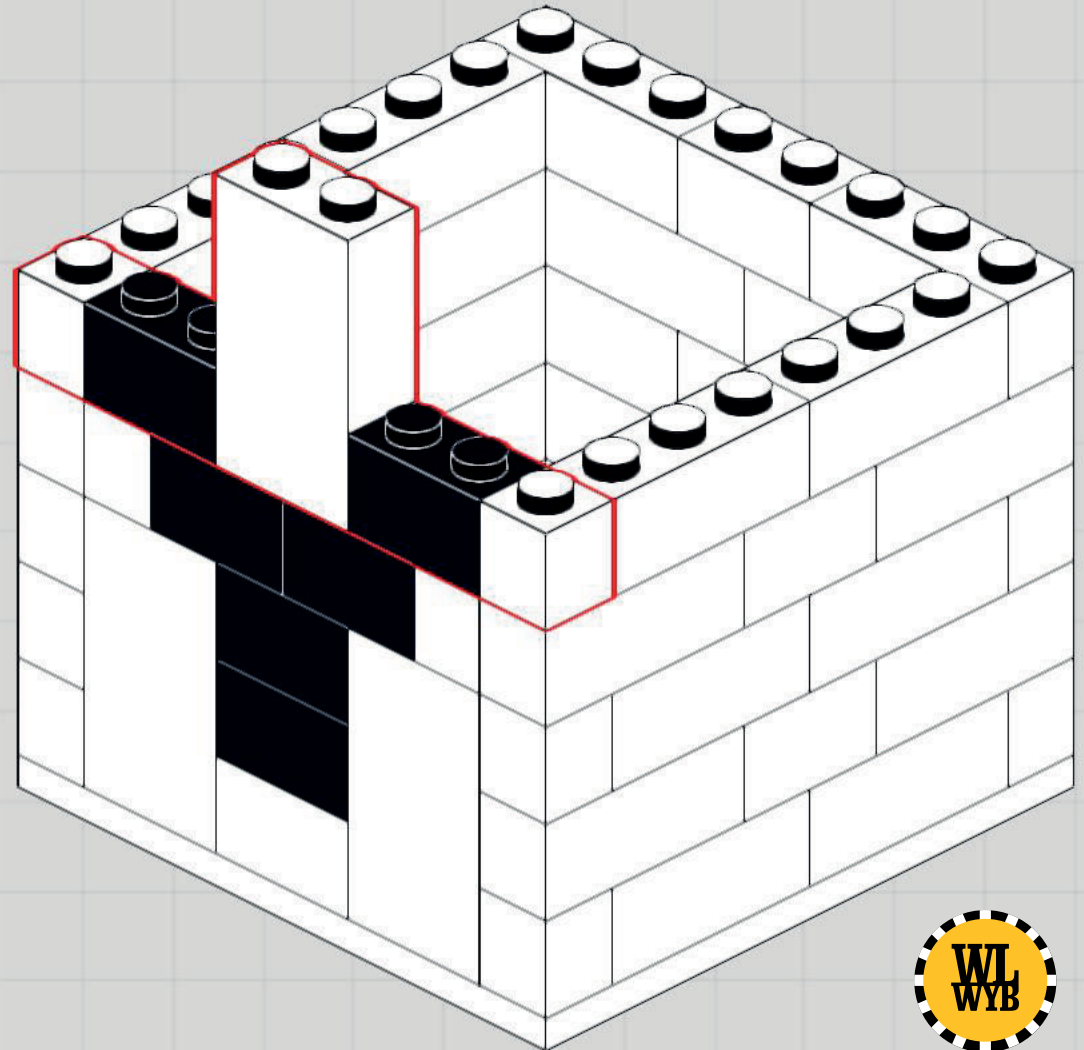

11

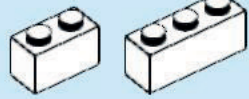

2x

6x

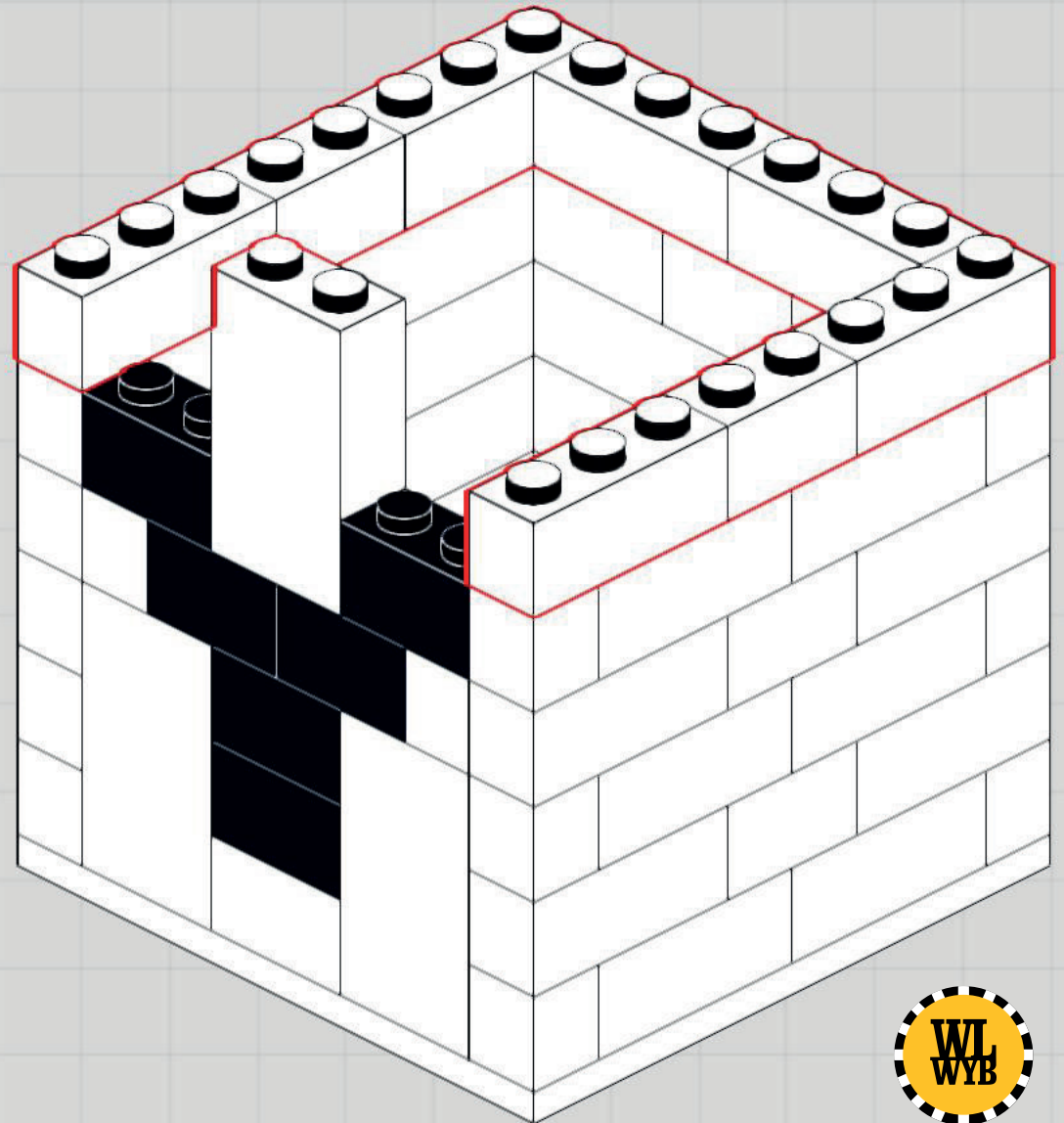

12



2x

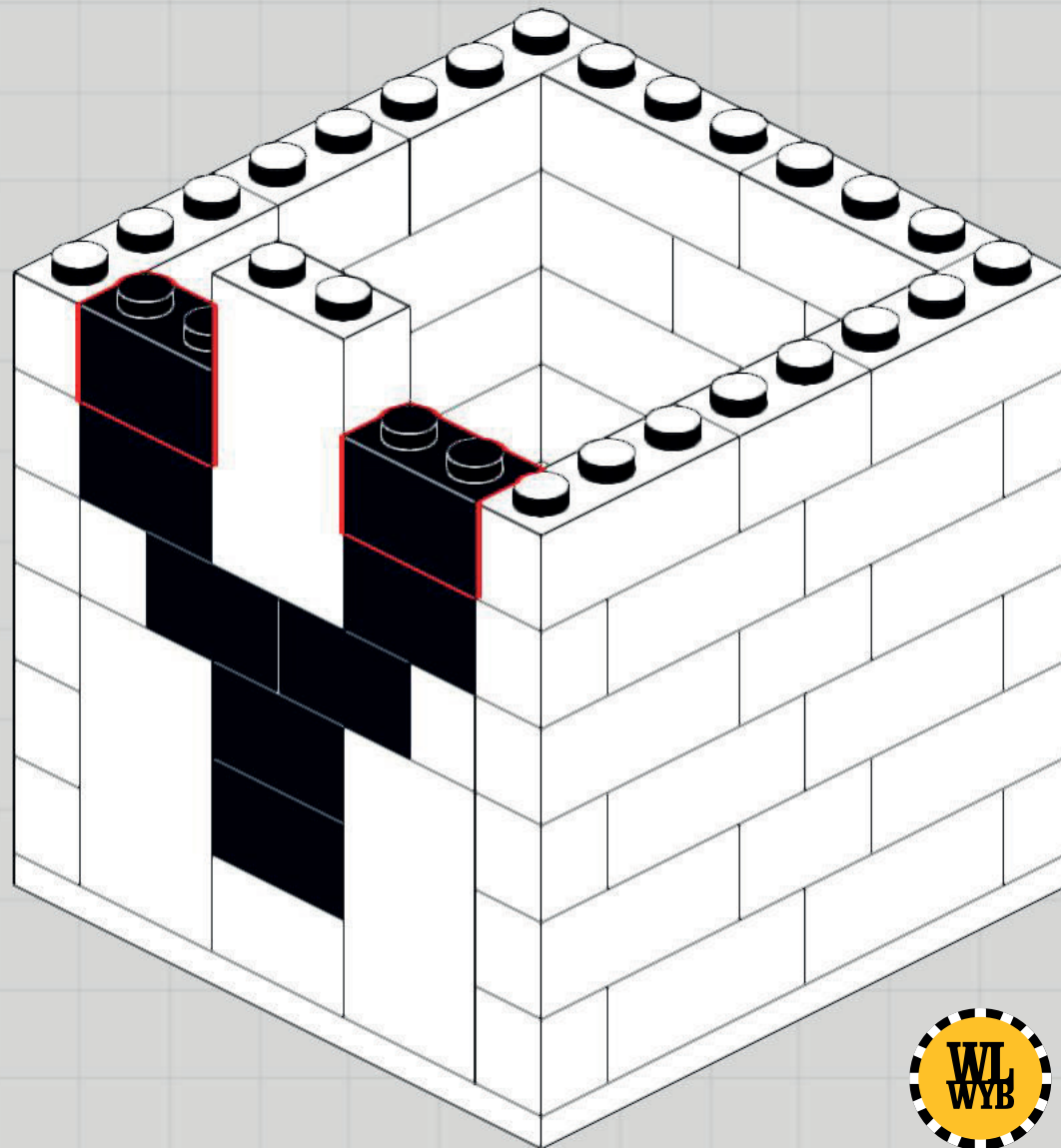

13

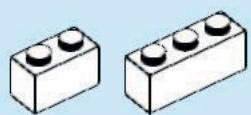

1x

6x

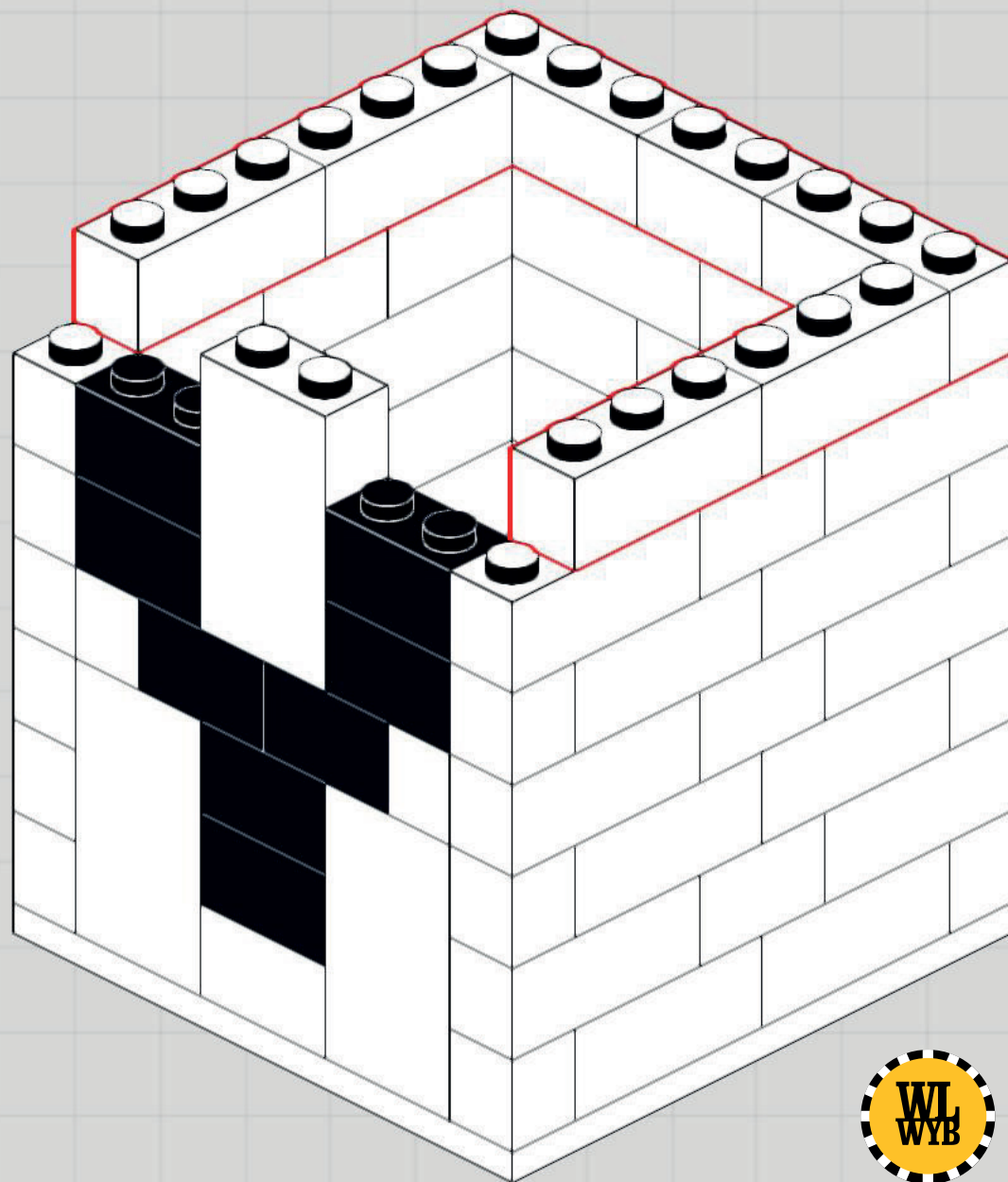

14

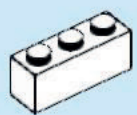

2x

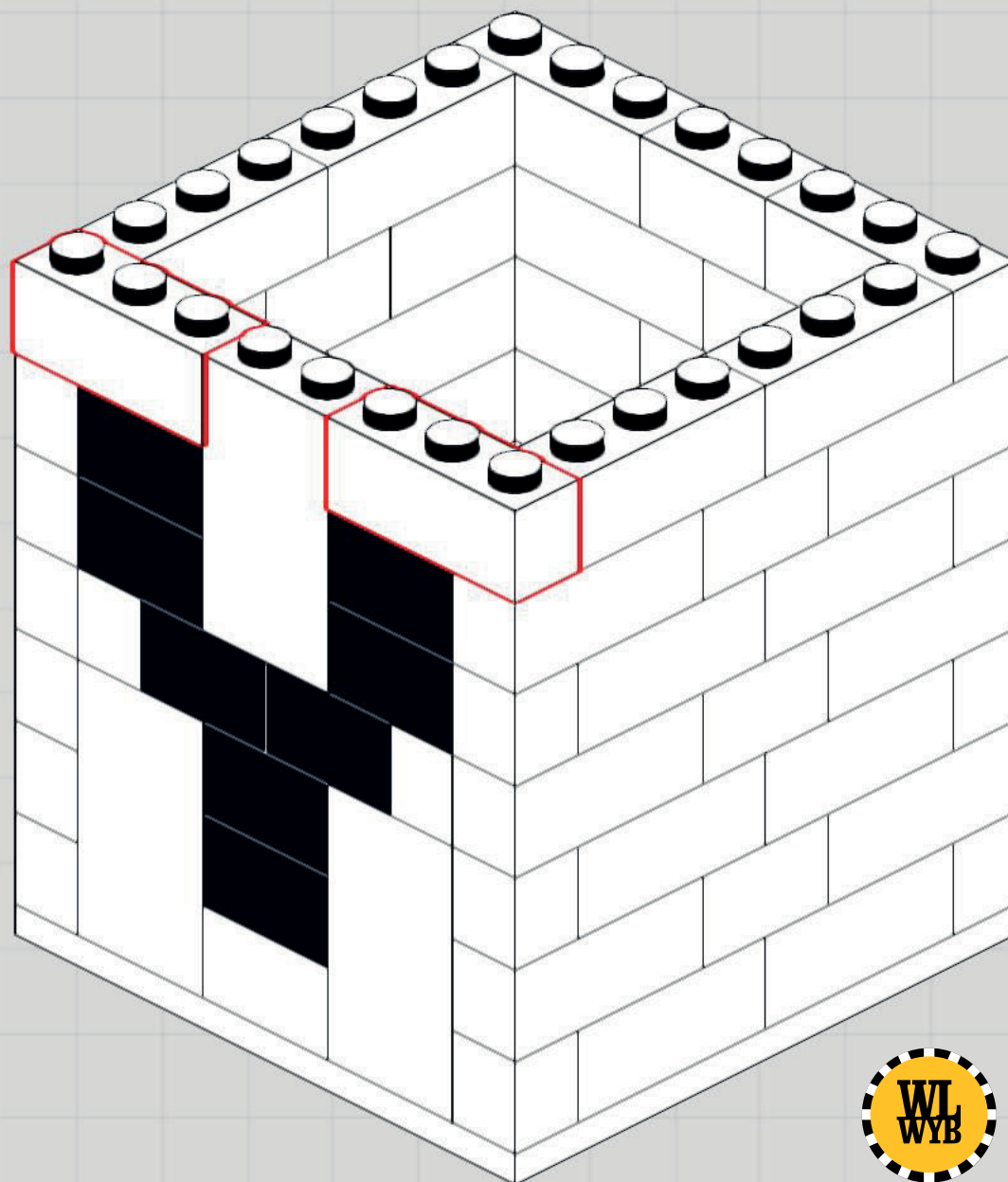

15

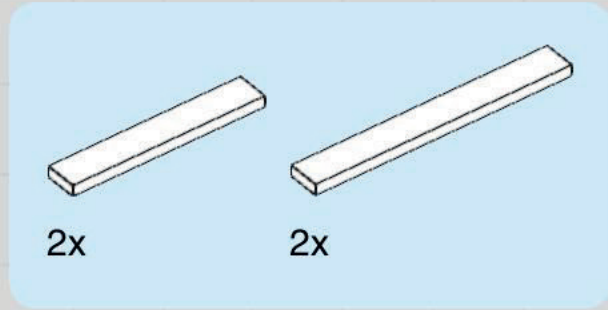

Warning: No drugs
or money kept in box.
Calf's teeth and tears
of joy only.

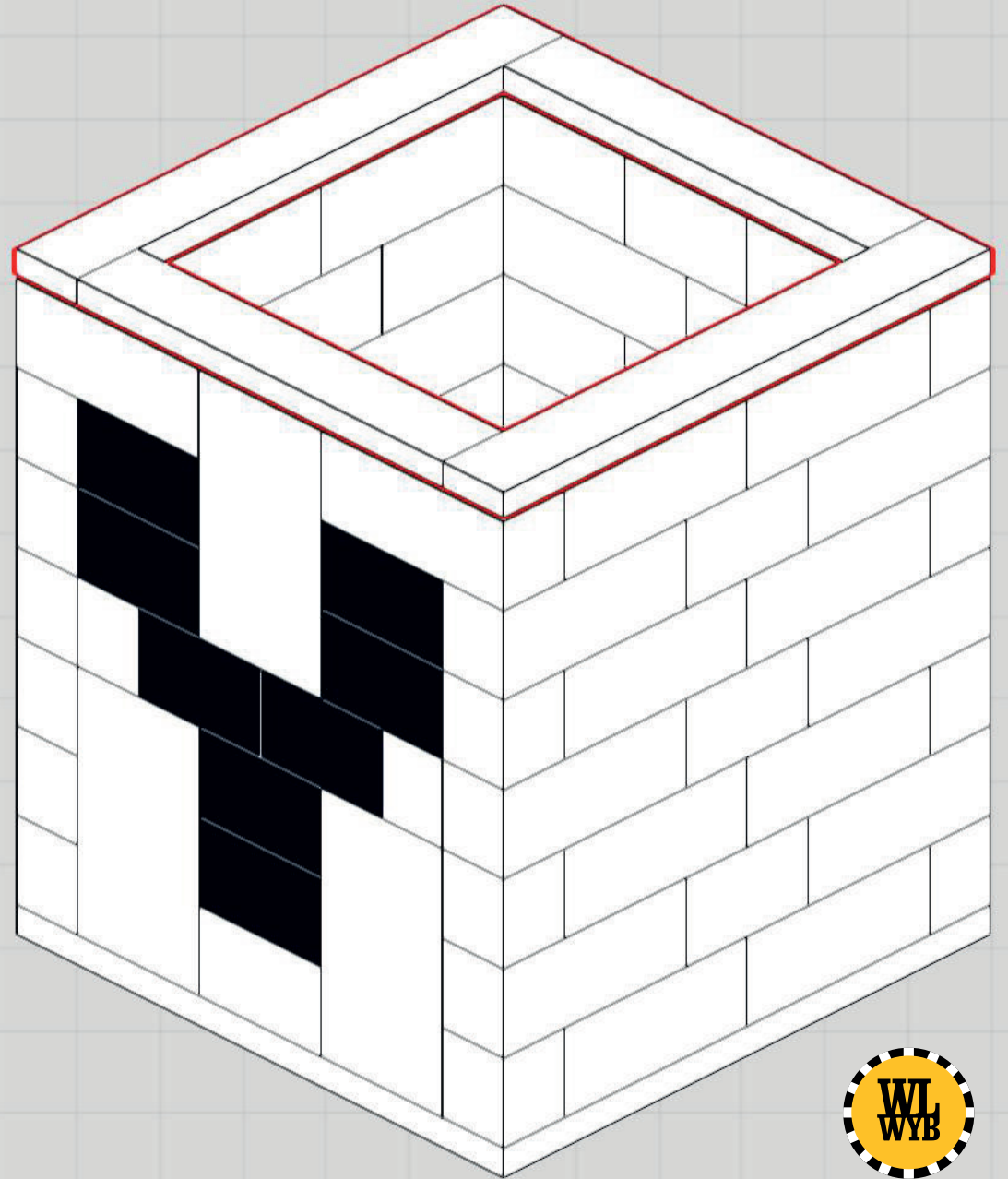

IMPORTANT:

Do not bleach or iron.

Do not bend, fold, spindle or mutilate.

Do not show your weakness.

Do not lock your keys in the car.

Do not wear white socks with black shoes.

DIGIT CUBE

www.wlwyb.com

